

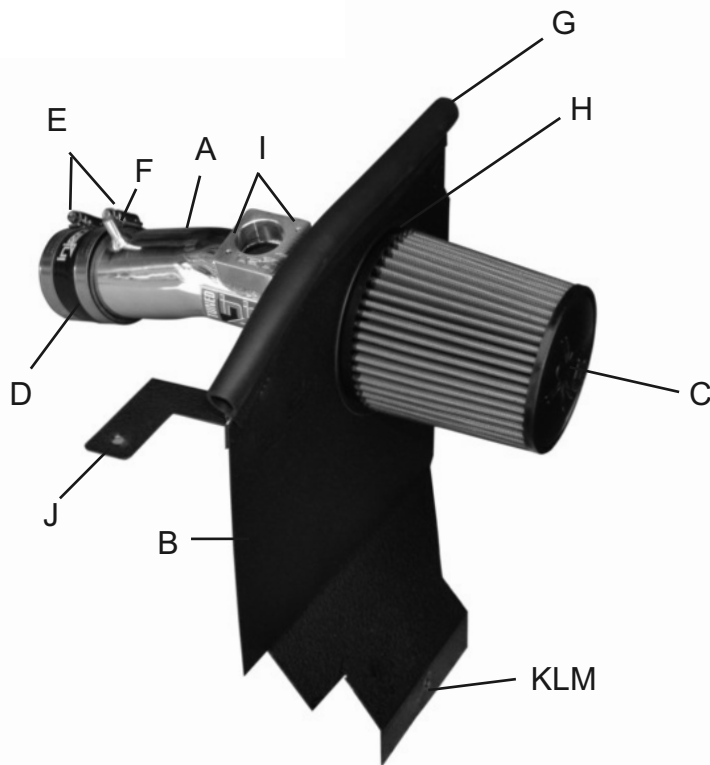

Vehicle Application:  
 Make: **Toyota**  
 Model: **iA**  
 Year: **2017**  
 Engine: **1.5L 4-cyl.**



Item	QTY.	P/N	Discription
A	1	Y-SP2025	Intake Tube
B	1	#11148	Heat shield
C	1	#1024	Dry filter
D	1	#3048	2.50" straight hose
E	2	#4009	#36 clamps
F	1	#3079	10mm hose @2.5"L
G	1	#6058	Rubber trim @ 10.5" Length
H	1	#6023	Vinyl trim @14"L
I	2	#6047	M4 button head screws
J	1	#6005	M6x16mm hex screw
K	1	#6006	M6x25mm hex screw
L	1	#8042	Nylon spacer
M	1	#6010	Fender washer

- TOOLS REQUIRED**
- 10mm Ratchet & Socket
  - 8mm nut drive
  - Allen key
  - Flat Blade Screwdriver
  - Philllips Screwdriver

**WARNING:** FAILURE TO FOLLOW INSTALLATION INSTRUCTIONS AND NOT USING THE PROVIDED HARDWARE MAY DAMAGE THE INTAKE SYSTEM, ENGINE AND COMPONENTS!!!  
**\*Do not attempt to install the intake system while the engine is hot.**  
 Severe burn could result from touching hot engine components!

Report any defective or missing parts to the authorized Injen dealer you purchased this product from. Before installing any parts of this system, please read the instructions thoroughly. If you have any questions regarding installation, please contact your Injen Technology dealer. Installation DOES require some mechanical skills. A qualified mechanic is always recommended.

A Limited Lifetime Warranty to the original purchaser against defects in material and workmanship on all Injen intake systems excluding the filter element. Any and all warranty coverage is limited to the repair or replacement of the defective part only, at Injen Technology's discretion. The warranty does not cover incidental or consequential damages, nor does it cover the cost of installation or removal of the defective part or its replacement. Proof of purchase is required.

# Instruction Manual P/N:SP2025

**NOTE:** This intake kit may not work on vehicles with the following aftermarket modifications.

- Aftermarket Intercooler piping
- Aftermarket intercooler
- Turbo upgrade
- Modified body panels
- Suspension & Chassis modifications

Injen intake systems are street legal in most states unless the state is adopting to California Emissions standards. States that have adopted California emission standards include: Arizona, California, Connecticut, District of Columbia, Maine, Maryland, Massachusetts, New Jersey, New Mexico, New York, Oregon, Pennsylvania, Rhode Island, Vermont, and Washington. These states will require an California Air Resource Board Executive Order Number (CARB E.O.) for the legal use of an Injen intake system in your vehicle for use on public roads or highways. These vehicle will be considered "Legal in California only for racing vehicles competition use only, which may never be used upon a public street or highway. **Please keep your factory air box assembly for any future use.**



The SuperNano-Web filter media is a dry synthetic media that outperforms the competition. The media itself is a proprietary base blend of synthetics and cellulose. Cellulose fibers are larger than synthetic fibers, and have larger spaces between the fibers, causing contaminants to load in the depth of the media and plug the airflow path. This creates higher restriction levels and less capacity. The synthetic fibers in the SuperNano-Web media are submicron in diameter and have small interior fiber spaces, which result in more contaminants being captured on the surface of the media. This can help keep restriction levels low as the filter loads with dirt and containments

If you look at the picture to the left, you can see the Nano-fiber web on top of our base media. That web, or SuperNano-Web as we like to call it, helps trap smaller particles and protect your engine.

### **To Clean your filter:**

Carefully remove the filter from the housing. Once removed, wipe down the housing using a clean shop towel, being careful not to knock any dirt and/or debris in the air inlet. Your filters can be cleaned by carefully vacuuming the filter media from the dirty side, or by holding the filter with one hand and carefully blowing the filter media at a 45-degree angle from the clean side using low-pressure shop air (15-20 lbs. psi).

***\*IT IS IMPORTANT TO NOT USE ANY CLEANERS ON THE SUPERNANO-WEB MEDIA OR APPLY ANY OIL!!!***

**NOTE: DISCONNECT BATTERY BEFORE INSTALLATION!!!**

# Instruction Manual P/N:SP2025



**1.** Stock intake system shown. Disconnect battery, vehicle may throw Check Engine Light if not disconnected. MAF sensor has constant voltage running even with vehicle off.



**2.** Lift up and remove engine cover.

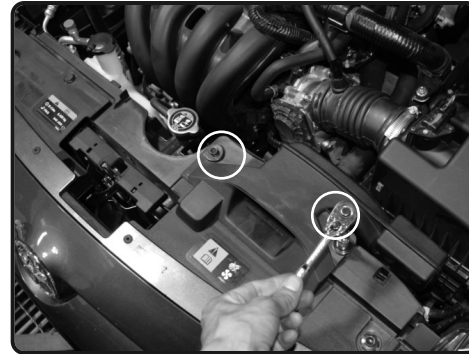

**3.** Loosen the 2 screws holding in the airbox using 10mm socket and ratchet. Save 1 screw for later install.



**4.** Lift up and remove the crankcase line from intake tube.

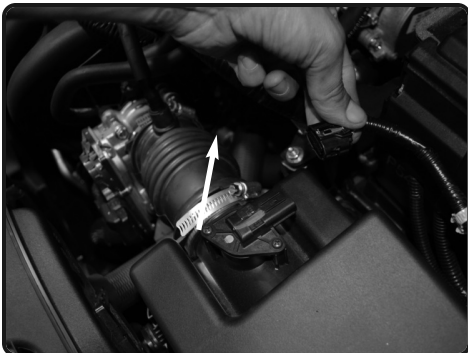

**5.** Disconnect MAF sensor harness and pull away from airbox.



**6.** Loosen the clamp on the throttle body using 7mm socket and ratchet.

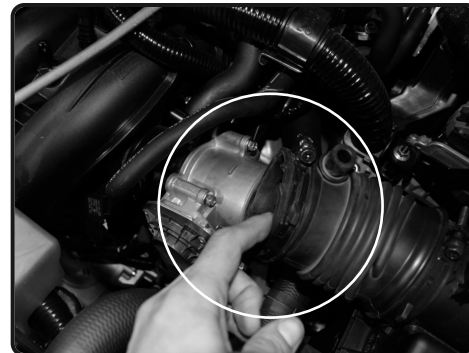

**7.** Pull back the intake tube from the throttle body.



**8.** Lift up and remove the complete stock intake system out of vehicle.



**9.** Loosen and remove the MAF sensor out of air box using phillips screwdriver.



**10.** Secure and install into the new injen intake tube using M4 screws. Tighten using 2.5mm allen key.

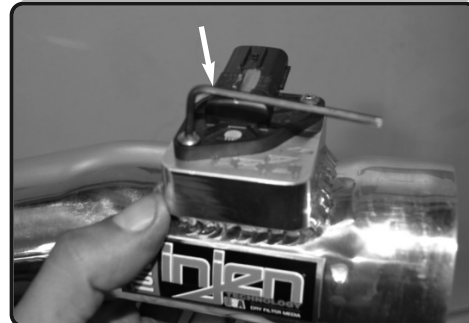

**11.** Install the step hose with clamps provided to the intake tube. Do not tighten.

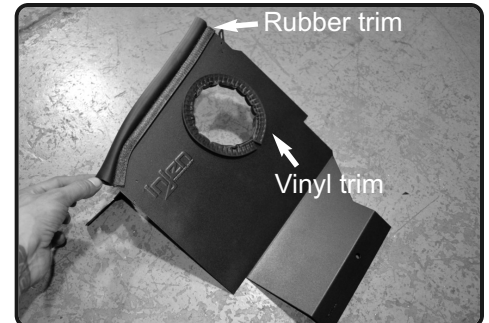

**12.** Install the rubber trim to the top of the heatshield. Install the vinyl trim to the hole in the center of the heatshield.

# Instruction Manual P/N:SP2025



**13.** Locate the Harness bracket, loosen the 10mm screw. This is where the Heatshield will be mounted to.

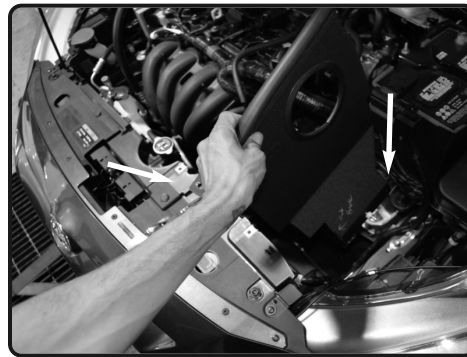

**14.** Position the heatshield into the vehicle, Do not secure.

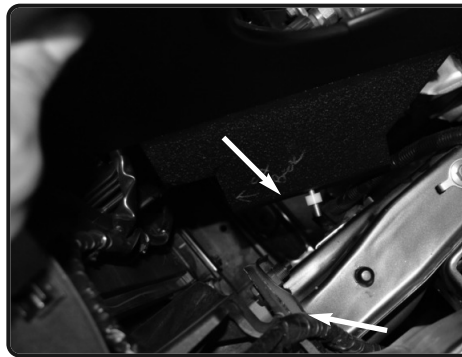

**15.** Use provided M6x25mm Hex screw and fender washer. Install to heatshield hole, now attach the nylon spacer to the hex screw. Do not tighten.

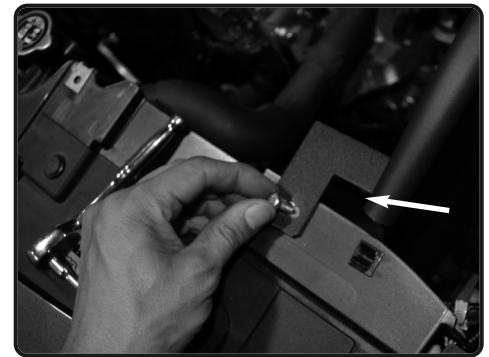

**16.** Now install M6x16mm hex screw to the tab and secure to the OEM airbox insert from step 3.

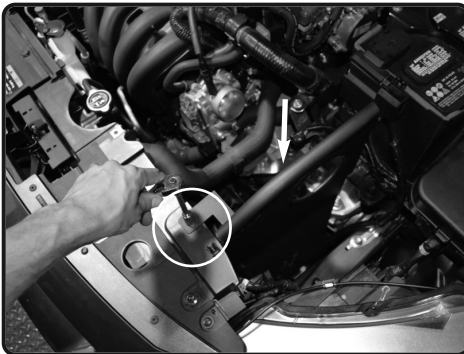

**17.** Secure and tighten the heatshield using 10mm socket or wrench.

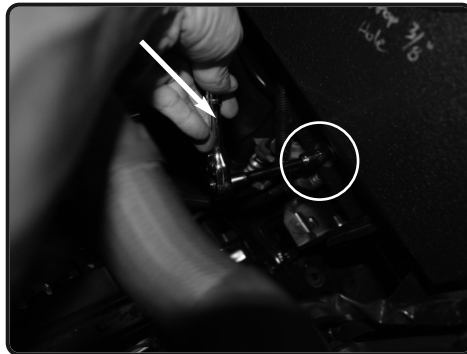

**18.** Tighten the bottom of the heatshield using 10mm socket or wrench.

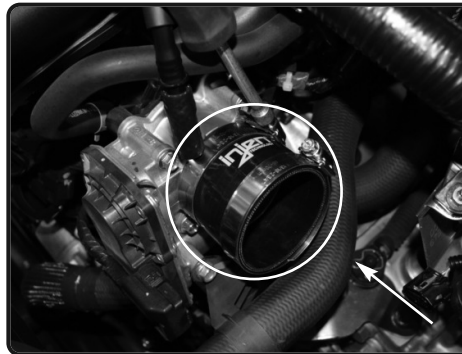

**19.** Install the straight hose with clamps provided to the throttle body. Tighten clamp on throttle body.



**20.** Install the intake tube into vehicle. Position the tube to the throttle body.

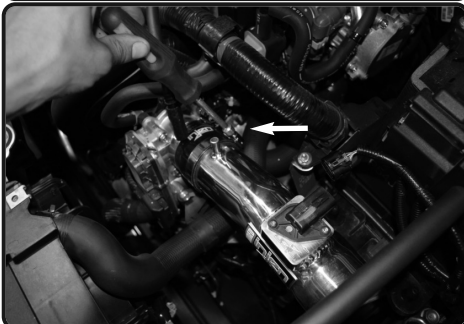

**21.** Adjust and position tube to the center hole of heatshield. Secure and tighten clamps on throttle body.

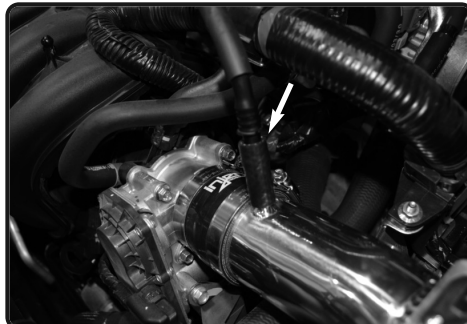

**22.** Install the provided 10mm hose to the fitting on intake tube. Secure the OEM plastic crankcase line to the 10mm hose.

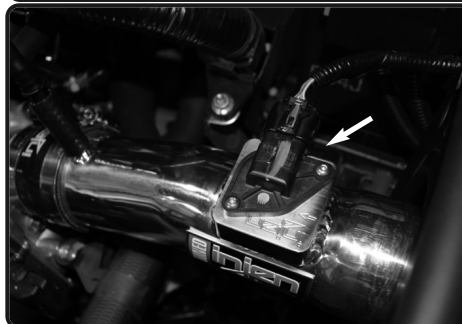

**23.** Reconnect the MAF sensor harness.

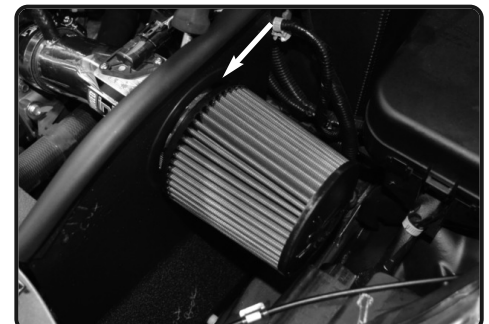

**24.** Install the filter to the intake tube, secure and tighten using 8mm nut driver.

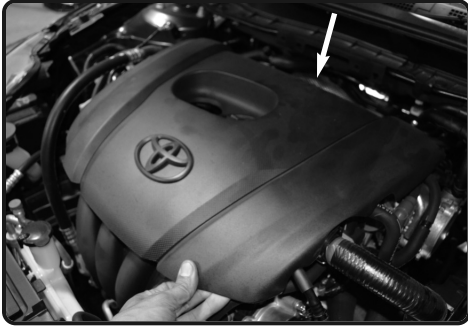

25. Re-install engine cover. Re-connect battery..



Congratulations! You have just completed the installation of this intake system. Periodically, check the alignment of the intake, normal wear and tear can cause nuts and bolts to come loose.  
**Note: Check clearance and adjust if needed! Failure to check the alignment and adjust the intake can cause damage that will void the warranty. Injen Technology is not responsible for any damages caused by/from improper installation.**

## Test Drive:

1. With the transmission in neutral or park and the parking brake engaged, start the engine. Listen for air leaks or odd noises. If air leaks are detected, secure hoses and connections. For any odd noises, inspect entire system for cause and adjust intake as needed. The Injen intake will function identically to the factory system but will be louder and more powerful.
2. Perform a road test. Listen for odd noises or rattles and fix as necessary.
3. If there are no issues, continue to enjoy your added performance from the Injen performance Intake kit.
4. Injen Technology recommends you periodically check clearance and adjust if needed! Failure to check the alignment and adjust the intake can cause damage that will void the warranty. Injen Technology is not responsible for any damages caused by/from improper installation.

1. Upon completion of the installation, reconnect the negative battery terminal before you start the engine.
2. Align the entire intake system for the best possible fit. Once the intake has been properly fitted continue to tighten all nuts, bolts and clamps.
3. Periodically, recheck the alignment of the intake system and make sure there is proper clearance around and along the length of the intake. Failure to follow proper maintenance procedures may cause damage to the intake and will void the warranty.
4. Start the engine and listen carefully for any odd noises, rattles and/or air leaks prior to taking it for a test drive. If any problems arise go back and check the vacuum lines, hoses and clamps that maybe causing leaks or rattles and correct the problem.
5. Check the filter for excessive dirt build up. Clean or replace the filter with an original Injen filter (can be bought on-line at "injenonline.com"). Congratulations! You have just completed the installation of the best intake system sold on the market. Enjoy the added power and performance of your new intake system.